

M80-42-S2

HEAVY VEHICLE JACKS

M80-42-S2

Mammut Air / Hydraulic heavy vehicle jacks are engineered and manufactured to offer all customers a lifting solution that is reliable, safe and easy to use.

- Lightweight, quiet, compact and easy to manoeuvre
- Now with new, faster motor
- Integrated remote control for extra safety
- Folding handle
- Wide range of models and capacities from 60 t to 150 t
- Designed for tough Australian conditions
- Pneumatic tires for easy operation
- Internal check valves to prevent unintentional decent
- Load Blocks available for mechanical lock and to turn jack into a jack stand

TECHNICAL DATA

	M80-42-S2
Capacity	80/50 t / 88.2/55.1 ton
Net weight	145 kg / 320 lb
Working air pressure	10-12 bar / 145-174 psi
Air consumption	600 nl / min
Max stroke	418 mm / 16.5 in
Min. height	420 mm / 16.5 in
Number of pistons	2
Pistons stroke	196 - 222 mm / 7.7 - 8.7 in

ACCESSORIES

#	Accessories
M4096	Remote Control
M4923	Load Block Holder
M4905	Safety Load Block H100 M/F 177mm
M4906	Safety Load Block H100 F/F 177mm
M4907	Safety Load Block H50 M/F 177mm
M4933	Extension Holder R
M4934	Extension Holder L
M4937	Extension 150 mm
M4938	Extension 250 mm
M4939	Extension 300 mm
LBS80	Load Block Set (Includes 3 x M4905, 1 x M4906, 1 x M4907, 1 x M4923)
A04492	Tilt Saddle

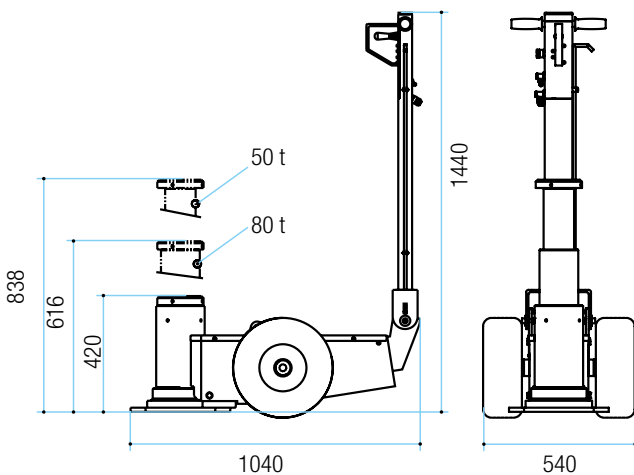



M80-42-S2

HEAVY VEHICLE JACKS

